

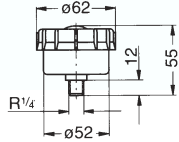

**Feinfilter mit Anschlußstutzen**  
*Fine filter with connector*

SD 12,  
SE 12,  
SD 12 B



SD 20  
SD 22  
SD 2n  
SD 2n-1  
SD 3  
SD 3-1

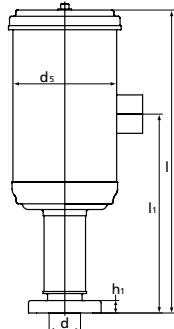
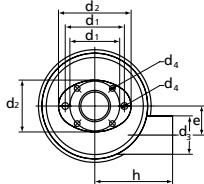

SD 24 –  
SD 820

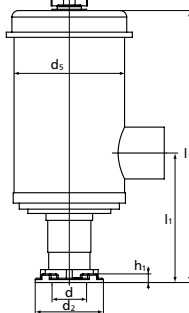
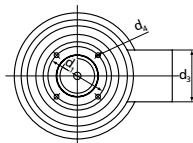

SD 90 –  
SD 900  
SD 120  
SD 140

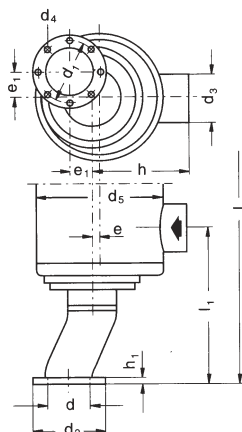

Typ / Type	l	l <sub>1</sub>	d	d <sub>1</sub>	d <sub>2</sub>	d <sub>3</sub>	d <sub>4</sub>	d <sub>5</sub>	e	e <sub>1</sub>	h	h <sub>1</sub>	Artikel-Nr. Article No.
SD 12, SE 12 SD 12 B	Maße siehe Abbildung / Dimensions see illustration												001192
SD 20, SE 20 SD 22, SE 22	292	192	27	48/ 57	50/ 70	37	5,5/ 6,5	100	28	-	75	12	013300
SD 2n, SE 2n SD 2n-1 SD 3n, SE 3n SD 3n-1	233	133	27	48/ 57	50/ 70	37	5,5/ 6,5	100	28	-	75	12	013301
SD 24, SE 24 SD 4n, SE 4n SD 4n-1 SD 42, SE 42 SD 400 SD 420	315	150	40	68	79	60	5,5	130	-	-	110	10	011805
SD 5, SE 5 SD 52, SD 54 SD 540 SD 5200 SD 5400 SD 6, SD 6-1 SD 62, SD 64 SD 600	383	150	50	85	100	60	7	150	-	-	110	10	011806
SD 6200 SD 6400 SD 7, SD 7-1 SD 72, SD 74 SD 740 SD 80, SD 8 SD 8-1 SD 82 SD 800 SD 820	440	175	68	110	130	100	9	190	-	-	155	12	011808
SD 90, SD 9 SD 9-1 SD 92 SD 900	637	357	80	118	145	100	9	240	16	44	185	12	011810
SD 120 SD 140	778	493	100	139	165	132	9,5	270	16	51	210	8	011791

**Ersatzpatronen zu Feinfilter**  
*Space cartridge for fine filter*

Typ / Type	Artikel-Nr. / Article No.
SD 12, SE 12	001261
SD 20 - SD 22	000447
SD 2n - SD 3n	000447
SD 24 - SD 420	011999
SD 5 - SD 600	012004
SD 6200 - SD 820	012003
SD 90 - SD 900	012002
SD 120, SD 140	011998



## Schalldämpfer mit Anschlußstutzen *Silencer with connector*

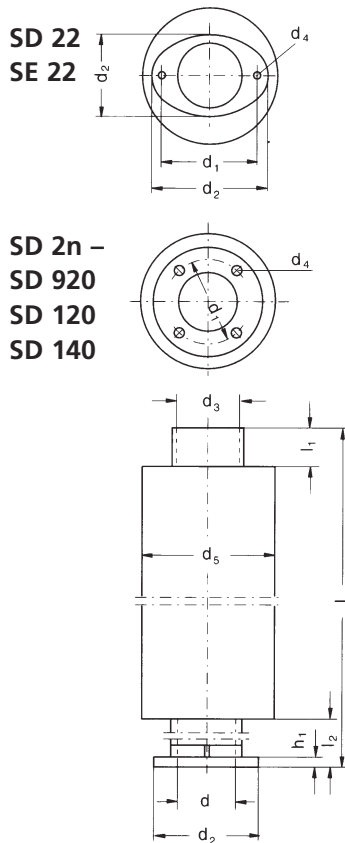

Typ Type	l	l <sub>1</sub>	l <sub>2</sub>	d	d <sub>1</sub>	d <sub>2</sub>	d <sub>3</sub>	d <sub>4</sub>	d <sub>5</sub>	h <sub>1</sub>	Schall- dämpfer Artikel- Nr. <i>Silencer Article No.</i>	Anschl.- stutzen Artikel- Nr. <i>Connector Article No.</i>
SD 20, SE 20	-	-	-	-	-	-	-	-	-	-	-	-
SD 22, SE 22	606	50	150	37	58	50/70	45	5,5	90	6	000826	001451
SD 2n, SE 2n SD 2n-1	606	50	150	38	58	70	45	5,5	90	6	000826	000114
SD 3, SE 3 SD 3-1	635	50	150	24	48	60	45	5,5	90	6	000826	004830
SD 24, SE 24 SD 4n, SE 4n SD 4n-1 SD 42, SE 42 SD 400, SD 420	608	50	150	45	68	79	55	5,5	100	8	000813	401276
SD 5, SE 5 SD 52, SD 54 SD 540, SD 5200 SD 5400	610	50	150	55	85	100	65	7	115	10	000605	400857
SD 6, SD 6-1 SD 62, SD 64 SD 600												
SD 6200 SD 6400	612	50	150	65	110	130	80	9	120	12	000603	400027
SD 7, SD 7-1 SD 72, SD 74 SD 740												
SD 80, SD 8 SD 8-1, SD 82 SD 800, SD 820												
SD 90, SD 9 SD 9-1, SD 92 SD 900	1012	50	162	80	118	145	97	9	150	12	004174	001270
SD 120, SD 140	1100	50	205	100	139	165	112	9,5	160	8	000751	000538



**Druckbegrenzungsventil  
Pressure and vacuum  
relief valves**

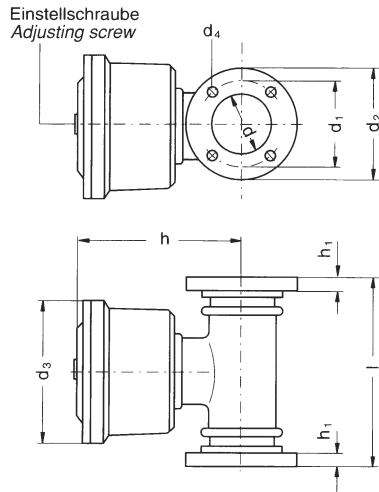

Typ Type	l	d	d <sub>1</sub>	d <sub>2</sub>	d <sub>3</sub>	d <sub>4</sub>	h	h <sub>1</sub>	saugseitige Drosselung Artikel-Nr. for use on vacuum side Article No.	druckseitige Drosselung Artikel-Nr. for use in pressure side Article No.
SD 2n, SE 2n SD 2n-1	-	-	-	-	-	-	-	-	-	-
SD 3, SE 3, SD 3-1	-	-	-	-	-	-	-	-	-	-
SD 24, SE 24	-	-	-	-	-	-	-	-	-	-
SD 4n, SE 4n SD 4n-1, SD 42 SE 42, SD 400	135	45	68	79	100	5,5	120	10	000592	000593
SD 420									000678	000679
SD 5, SE 5, SD 52 SD 54, SD 540 SD 5200, SD 5400	180	53	85	100	125	7	150	10	000509	000510
SD 6, SD 6-1 SD 62, SD 64 SD 600										
SD 6200, SD 6400	205	68	110	130	145	9	178	12	000662	000663
SD 7, SD 7-1 SD 72, SD 74 SD 740										
SD 80, SD 8 SD 8-1, SD 82									000442	000443
SD 800, SD 820									000662	000663
SD 90, SD 9 SD 9-1, SD 92 SD 900	225	80	118	145	180	9	188	12	001269	001268
SD 120, SD 140	248	108	139	165	180	9	202,5	30	000571	000572

**Zwischenstück  
bei Ausführung mit Feinfilter  
und Druckbegrenzungsventil  
druckseitig**

**Intermediate tubes  
necessary with fine filter  
and excess pressure valve**

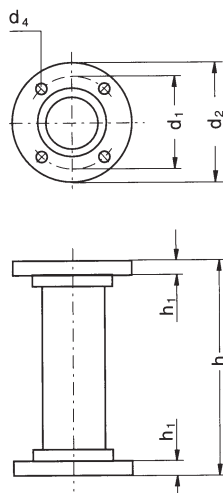

Typ / Type	d <sub>1</sub>	d <sub>2</sub>	d <sub>4</sub>	h	h <sub>1</sub>	Artikel-Nr. / Article No.
SD 2n, SE 2n SD 2n-1	-	-	-	-	-	-
SD 3, SE 3, SD 3-1	-	-	-	-	-	-
SD 24, SE 24	-	-	-	-	-	-
SD 4n, SE 4n SD 4n -1, SD 42 SE 42, SD 400 SD 420	68	79	6	140	10	001164
SD 5, SE 5, SD 52 SD 54, SD 540 SD 5200, SD 5400 SD 6, SD 6-1 SD 62, SD 64 SD 600	85	100	7	185	10	000345
SD 6200, SD 6400 SD 7, SD 7-1, SD 72 SD 74, SD 740 SD 80, SD 8, SD 8-1 SD 82, SD 800 SD 820	110	130	9	240	12	001163
SD 120, SD 140	139	165	9	270	30	000569



## Drosselklappe Throttle valve

SD 22  
SE 22

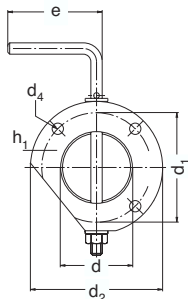

(Befestigung erfolgt beim SD 22/SE 22 nur an zwei Bohrungen.)

(Only two boreholes fixing the SD22/SE 22.)

SD 2n –  
SD 140

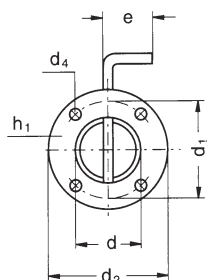

## Schutzgitter Wire mesh guards

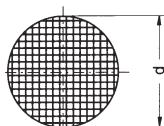

Typ / Type	d	d <sub>1</sub>	d <sub>2</sub>	d <sub>4</sub>	e	h <sub>1</sub>	Artikel-Nr. / Article No.
SD 20, SE 20	-	-	-	-	-	-	-
SD 22, SE 22	38	58	70	6	50	12	011867
SD 2n, SE 2n SD 2n-1	38	58	70	6	34	12	000111
SD 3, SE 3, SD 3-1	24	48	60	6	34	12	000112
SD 24, SE 24, SD 4n SE 4n, SD 4n-1 SD 42, SE 42 SD 400, SE 420	45	68	79	6	34	12	000105
SD 5, SE 5, SD 52 SD 54, SD 540 SD 5200, SD 5400 SD 6,, SD 6-1 SD 62, SD 64 SD 600	55	85	100	7	34	12	000373
SD 6200, SD 6400 SD 7, SD 7-1, SD 72 SD 74, SD 740 SD 80, SD 8, SD 8-1 SD 82, SD 800 SD 820	65	110	130	9	50	12	000559
SD 90, SD 9 SD 9-1, SD 92 SD 900	80	118	145	9	70	12	001271
SD 120, SD 140	98	139	165	9	100	23	000738

Typ Type	d	Maschenweite 0,32 Artikel-Nr. Mash width 0,32 Article No.	Maschenweite 8 Artikel-Nr. Mash width 8 Article No.
SD 20, SE 20	33	008687	008688
SD 22, SE 22	40	008689	008690
SD 2n, SE 2n SD 2n-1, SD 3 SE 3, SD 3-1	70	000460	000464
SD 24, SE 24 SD 4n, SD 4n-1 SD 42, SE 42 SD 400, SD 420	85	000461	000465
SD 5, SE 5, SD 52 SD 54, SD 540 SD 5200, SD 5400 SD 6, SD 6-1, SD 62 SD 64, SD 600	113	000462	000466
SD 6200, SD 6400 SD 7, SD 7-1, SD 72 SD 74, SD 740 SD 80, SD 8, SD 8-1 SD 82, SD 800 SD 820	133	000463	000467
SD 90, SD 9, SD 9-1 SD 92, SD 900	148	001319	001320
SD 120, SD 140	155	000575	000577



**Gewindeflansch  
Threaded flanges**

**SD 20  
SE 20**

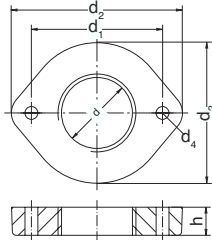

**SD 22  
SE 22**

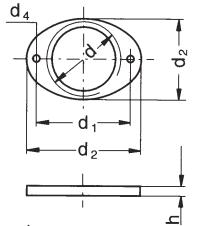

**SD 2n –  
SD 900  
SD 120  
SD 140**

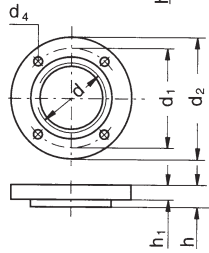

Typ Type	d	d <sub>1</sub>	d <sub>2</sub>	d <sub>4</sub>	h	h <sub>1</sub>	Artikel-Nr. Article No.
SD 20, SE 20	G1" x 12	56	60/73	5,5	12	-	001462
SD 22, SE 22	G1 1/4" x 12	58	50/70	5,5	12	-	001452
SD 2n, SE 2n SD 2n-1	G1 1/4" x 10	58	70	5,5	10	10	000109
SD 3, SE 3, SD 3-1	G3/4" x 10	48	60	5,5	10	10	000110
SD 24, SE 24, SD 4n SE 4n, SD 4n-1 SD 42, SE 42 SD 400, SE 420	G1 1/2" x 15	68	79	6	15	10	000103
SD 5, SE 5, SD 52 SD 54, SD 540 SD 5200, SD 5400 SD 6, SD 6-1 SD 62, SD 64 SD 600	G2" x 15	85	100	7	15	10	000372
SD 6200, SD 6400 SD 7, SD 7-1, SD 72 SD 74, SD 740 SD 80, SD 8, SD 8-1 SD 82, SD 800 SD 820	G2 1/2" x 20	110	130	9	20	12	000439
SD 90, SD 9 SD 9-1, SD 92 SD 900	G3" x 20	118	145	9	20	12	001272
SD 120, SD 140	G4" x 30	139	165	9	30	-	007376

**Schweißflansch  
Welding flanges**

**SD 20**

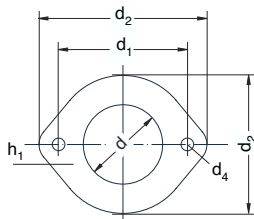

**SD 22**

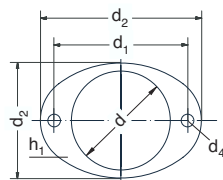

**SD 24 –  
SD 140**

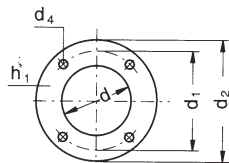

Typ Type	d	d <sub>1</sub>	d <sub>2</sub>	d <sub>4</sub>	h <sub>1</sub>	Artikel-Nr. Article No.
SD 20, SE 20	34,5	56	60/73	5,5	6	011928
SD 22, SE 22	43	58	50/70	5,5	6	011929
SD 2n, SE 2n SD 2n-1	38	58	70	5,5	10	011897
SD 3, SE 3, SD 3-1	24	48	60	5,5	10	011896
SD 24, SE 24, SD 4n SE 4n, SD 4n-1 SD 42, SE 42 SD 400, SE 420	49	68	79	5,5	10	011898
SD 5, SE 5, SD 52 SD 54, SD 540 SD 5200, SD 5400 SD 6, SD 6-1 SD 62, SD 64 SD 600	61	85	100	7	12	011902
SD 6200, SD 6400 SD 7, SD 7-1, SD 72 SD 74, SD 740 SD 80, SD 8, SD 8-1 SD 82, SD 800 SD 820	76,5	110	130	9	12	011906
SD 90, SD 9 SD 9-1, SD 92 SD 900	90	118	145	9	12	011909
SD 120, SD 140	115,5	139	165	9,5	12	011912



## Anschlußstutzen Connectors

SD 12  
SE 12  
SD 12 B

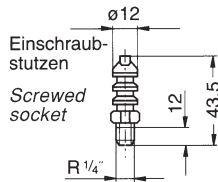

SD 20  
SE 20  
SD 22  
SE 22

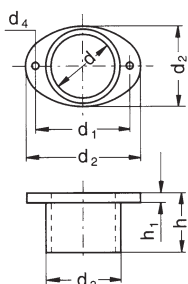

SD 2n –  
SD 900  
SD 120  
SD 140

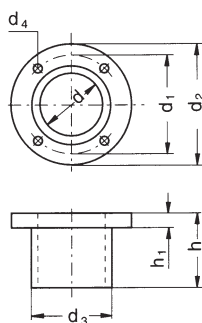

Typ Type	d	d <sub>1</sub>	d <sub>2</sub>	d <sub>3</sub>	d <sub>4</sub>	h	h <sub>1</sub>	Artikel-Nr. Article No.
SD 12, SE 12 SD 12 B	Maße siehe Abbildung / Dimensions see illustration							001193
SD 20, SE 20	30	56	60/73	41	5,5	35	6	000301
SD 22, SE 22	37	58	50/70	45	5,5	35	6	001451
SD 2n, SE 2n SD 2n-1	38	58	70	45	5,5	35	6	000114
SD 3, SE 3, SD 3-1	24	48	60	30	5,5	35	6	000115
SD 24, SE 24, SD 4n SE 4n, SD 4n-1 SD 42, SE 42 SD 400, SD 420	45	68	79	54	5,5	50	8	401276
SD 5, SE 5, SD 52 SD 54, SD 540 SD 5200, SD 5400 SD 6, SD 6-1, SD 62 SD 64, SD 600	55	85	100	65	7	50	10	400857
SD 6200, SD 6400 SD 7, SD 7-1, SD 72 SD 74, SD 740 SD 80, SD 8, SD 8-1 SD 82, SD 800 SD 820	65	110	130	80	9	60	12	400027
SD 90, SD 9, SD 9-1 SD 92, SD 900	81	118	145	97	9	60	12	001270
SD 120, SD 140	94	139	165	100	9	100	6	007716